

# playmobil

70089

 **WARNING:**  
**CHOKING HAZARD**  
Small parts. Not for children under 3 years.

"Ne concerne que les USA"

Wichtige Unterlagen, bitte sorgfältig aufbewahren!  
Important: Please keep these instructions for future reference!  
Documents importants, à conserver soigneusement!  
Belangrijke documenten, bewaar deze zorgvuldig!



**UK-Importer:**  
**Playmobil UK Ltd.**  
**Regency House**  
**1 Miles Gray Road**  
**Basildon**  
**Essex**  
**SS14 3RW**  
**UK**

**UK**  
**CA**

Serviceadressen finden Sie in allen PLAYMOBIL-Prospekten

Addresses of Customer Service Departments are shown in all PLAYMOBIL catalogues

L'adresse du service consommateurs est indiquée dans tous les catalogues PLAYMOBIL

Troverete gli indirizzi dei centri di assistenza in tutti i cataloghi PLAYMOBIL

In alle PLAYMOBIL catalogi vindt u het adres van onze klantendienst.

Las Direcciones de los departamentos de Servicio al Consumidor se encuentran en todos los catálogos PLAYMOBIL

Η διεύθυνση του Γραφείου Εξυπηρέτησης Καταναλωτών PLAYMOBIL βρίσκεται σε όλους τους καταλόγους PLAYMOBIL.

pronounced: plāy-mō-bēil

1



24 25  
34 35

2 3 4 5 6 7 8 9

© 2009 gebirga Brandstatter  
Dr. Burg & Co. KG  
Draht- & Metallwarenfabrik - 3-10  
89613 Eimsdorf-Gleimberg  
Tel. 36702070 07 59



30 82 0015

9

30 25 0033

This block contains a parts list for step 1. It features a grid of numbered icons (24, 25, 34, 35) and various technical drawings of components. A line connects icon 9 to a grey rectangular component shown below. The part number 30 82 0015 is associated with the grid, and 30 25 0033 is associated with the component.

3x



30 03 2920

30 25 2810

This block shows three flower stems (part 30 03 2920) and a circular inset showing a single flower head (part 30 25 2810).

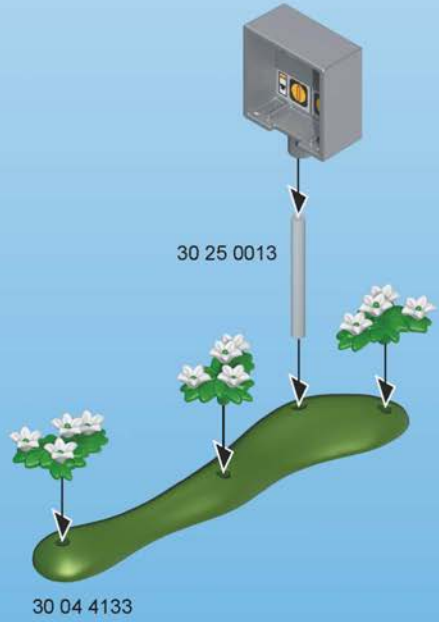

2

# 2

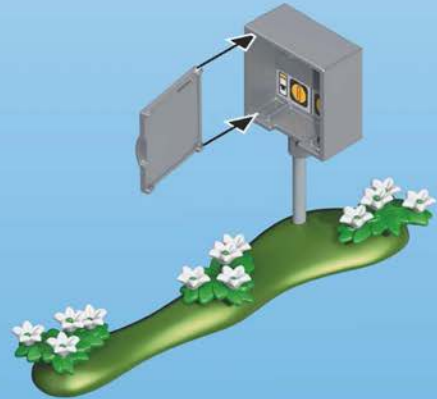
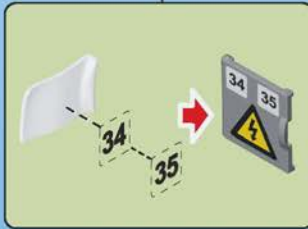
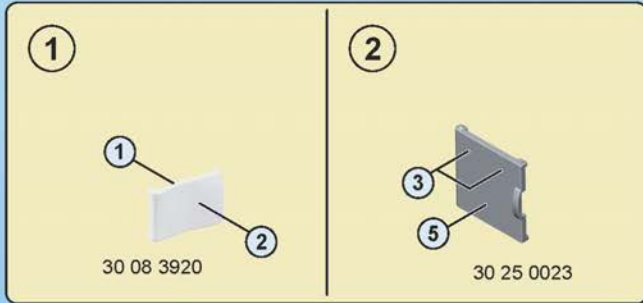

3

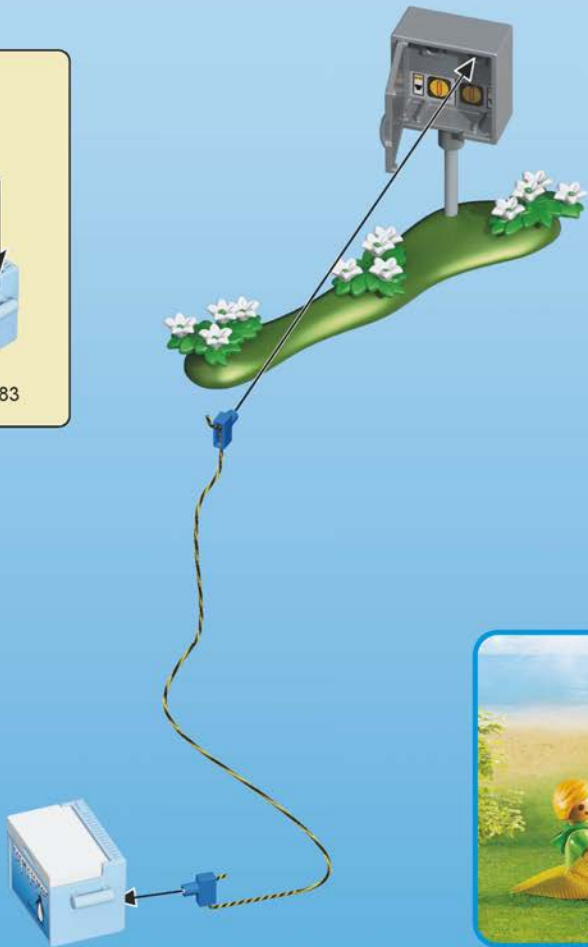
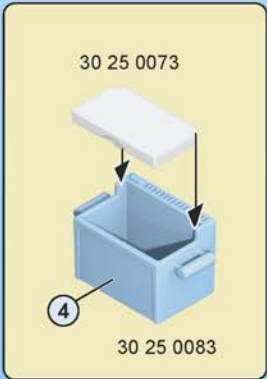

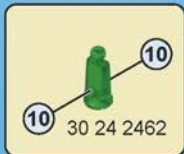
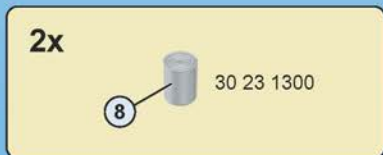
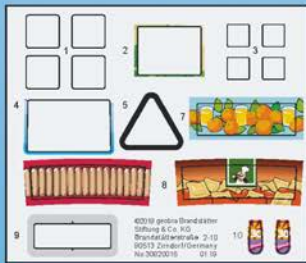
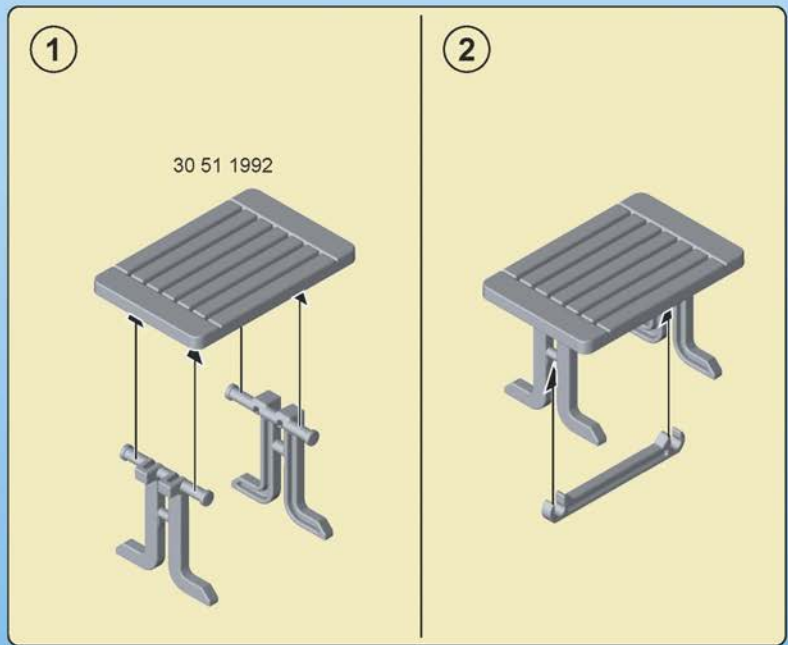
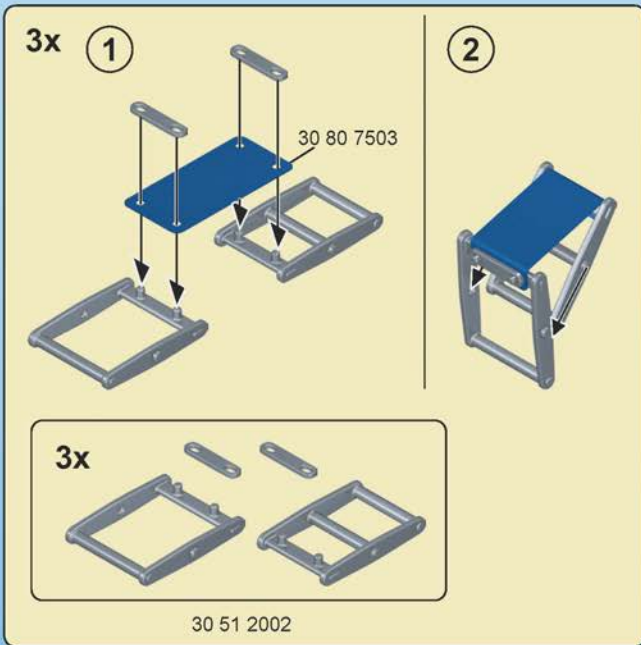





30 00 4264



30 10 4420



30 11 4090

30 62 4526



30 60 2442



30 80 9323



30 82 4764



2x 30 82 4754

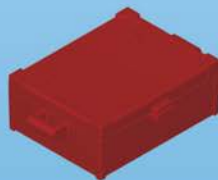

30 25 0123



30 25 2602



30 65 2152



30 25 0153



30 61 2170



30 51 4790



30 25 0312



30 23 8012



3x 30 25 0113



3x 30 25 0133

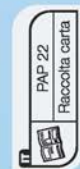

© 2019 geobra Brandstätter Stiftung & Co.KG  
Brandstätterstr. 2-10  
90513 Zirndorf, Germany.  
No. 30 81 1636 05.22

